



AP125 INDOOR ACCESS POINT

Dual radio 2x2:2 MU-MIMO, 802.11ac Wave 2

4 integrated antennas, 2 GbE ports, 802.3af PoE power

Great Wi-Fi security comes in affordable, small packages. The AP125 from WatchGuard is exactly what you've been looking for – a small and affordable indoor access point that comes equipped with 2x2 802.11ac Wave 2 Multi-User MIMO (MU-MIMO). This access point also offers dual concurrent 5 GHz and 2.4 GHz band radios, and data rates of up to 867 Mbps and 300 Mbps, respectively. Common use cases include lower-density environments such as small schools, distributed remote offices, and small meeting rooms.

With this powerful little beast, we can deliver and guarantee a high quality Wi-Fi network, protected by WIPS which will make the customer happy for many years to come.

~Jean-Pierre Schwickerath, Head of IT, HILOTEC AG

UNIQUELY EFFECTIVE APPROACH TO SECURITY

The AP125 supports the only Wireless Intrusion Prevention System (WIPS) in the industry with high accuracy in classifying access points and client devices, properly enabling automatic prevention of Wi-Fi threats and keeping a network protected from wireless man-in-the-middle attacks, evil twins, honeypots, and more.

FLEXIBLE MANAGEMENT OPTIONS

You can manage the AP125 with either a Firebox®, via the Gateway Wireless Controller and receive a lightweight feature set, or with WatchGuard's Wi-Fi Cloud.

With the Wi-Fi Cloud you get an expanded set of features including patented security, social-enabled captive portals, and location-based analytics for optimal business insights. IT pros can also enjoy an entirely controller-less Wi-Fi management experience including setup, configuration, monitoring, troubleshooting, and improved corporate and guest Wi-Fi access, without worrying about the limitations of legacy controller infrastructure. Wi-Fi Cloud environments easily scale from one to an unlimited number of access points across multiple locations. Access points can be grouped in many ways including location, building, floor, and customer to maintain consistent policies.

PERFORMANCE WITHOUT COMPROMISE

Incorporating the latest 802.11ac Wave 2 standards, you'll have speeds of up to 867 Mbps over the air, without sacrificing security. With MU-MIMO, you get a faster user experience, serving multiple devices (smartphones, tablets, laptops) at the same time, so more clients can utilize the network more efficiently.

FEATURES & BENEFITS

- Wave 2 chipset offers the latest MU-MIMO technology to provide optimal airtime efficiency
- Measuring under 6 inches (148mm) square, this small access point packs a real punch
- AP125 takes less than two minutes to activate and configure after connecting to the Wi-Fi Cloud
- Support for up to eight individual SSIDs per radio allows for maximum flexibility in network design
- Smart steering automatically pushes clients with low speeds to a closer access point*
- Band steering manages spectrum efficiency, pushing clients to 5 GHz channels for optimal throughput
- AP125 continues to scan for wireless threats and enforces security policy even if the connection with the Wi-Fi Cloud is interrupted*

*Must have Wi-Fi Cloud enabled with Secure Wi-Fi or Total Wi-Fi license

PHYSICAL SPECIFICATIONS

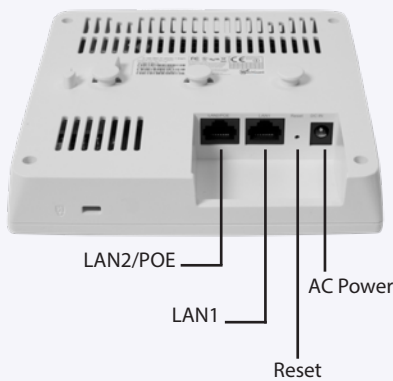

Property		Specification	
Physical Dimensions		148mm X 148mm X 33mm	
Weight		237g (0.522 lb)	
Operating Temperature		0° - 45°C (32°F - 113°F)	
Storage Temperature		-20°C to 65°C (-4°F to 149°F)	
Humidity		5% to 95% non-condensing	
Processor RAM		Qualcomm IPQ4028 717 MHz quad-core ARM processor with 256 MB RAM and 64 MB Flash.	
Port	Description	Connector Type	Speed/Protocol
Power	12V DC/802.3af (PoE)	5.5MM overall diameter/2.1mm center pin/hole	N/A
Reset	Reset to factory default settings	Pin hole push button	Hold down and power cycle the device to reset
LAN1	Gigabit Ethernet port that can be used for wired extension for an SSID	RJ-45	10/100/1000 Mbps Gigabit Ethernet
LAN2/ PoE	Gigabit Ethernet port used to connect to the wired LAN and communicate with the WatchGuard Wi-Fi Cloud. This port can also be used to power the device using the 802.3af (PoE) standard.	RJ-45	10/100/1000 Mbps Gigabit Ethernet 802.3af Class 0 PoE PoE input voltage: 48V

WI-FI SPECIFICATIONS – Frequency, Modulation, and Data Rates

IEEE 802.11b/g/n			
Frequency Band	Scanning	Transmission	
	All regions	USA & Canada (FCC/IC)	Europe (ETSI)
	2400 ~ 2483.5 MHz	2400 ~ 2473.5 MHz	2400 ~ 2483.5 MHz
Modulation Type	DSSS, OFDM		
Peak Data Rates	Up to 300Mbps (MCS 0-15)		
Antenna	Integrated modular high efficiency PIFA antenna x4 (2 per band)		

IEEE 802.11a/n/ac			
Frequency Band	Scanning	Transmission	
	All regions	USA & Canada (FCC/IC)	Europe (ETSI)
	4.92 ~ 5.08 GHz 5.15 ~ 5.25 GHz 5.25 ~ 5.35 GHz 5.47 ~ 5.725 GHz 5.725 ~ 5.825 GHz	5.15 ~ 5.25 GHz 5.25 ~ 5.35 GHz 5.725 ~ 5.825 GHz	5.15 ~ 5.25 GHz 5.25 ~ 5.35 GHz 5.47 ~ 5.725 GHz
Dynamic Frequency Selection	DFS and DFS2		
Modulation Type	OFDM		
Peak Data Rates	Up to 867 Mbps (MCS 0-15)		
Antenna	Integrated modular high efficiency PIFA omnidirectional antenna		

Operational Specifications	
Input Power	12V DC/1.5A (5.5mm overall diameter/2.1 center pin/hole)/802.3af (PoE)
Number of Radios	2 radios; One 2.4GHz and 5GHz radio each for simultaneous dual band client access.
Max Clients Supported	512 clients per radio *dependent upon cases
MIMO	2x2 for 2.4/5GHz Radios
Number of Spatial Streams	2 for 2.4/5GHz Radios
RF Transmit Power	20 dBm per radio chain (max); Actual power for Tx will depend on Country Regulatory Doman
Simultaneous MU-MIMO Clients	Two 1x1 MU-MIMO clients
Users in a MU-MIMO group with a 2x2 client	1
Bandwidth Agility	Yes
Frequency Bands	2.4-2.4835 GHz, 4.9-5.0GHz, 5.15-5.25 GHz; (UNII-1), 5.25-5.35 GHz, 5.47-5.6 GHz, 5.650-5.725 GHz (UNII-2), 5.725-5.85 GHz (UNII-3)
Dynamic Frequency Selection	Supported in compliance to all latest amendments from FCC, CE, IC, CB, TELEC, KCC regarding certifications.

INTERNAL ANTENNA RADIATION PATTERNS

2.4 GHz Antenna

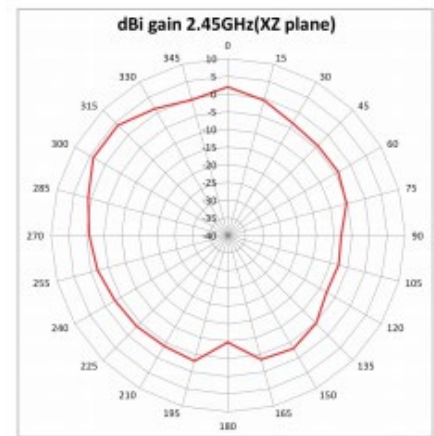
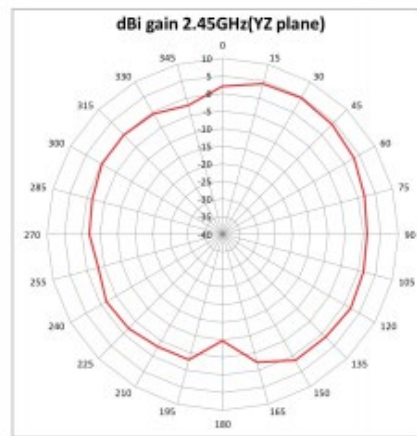
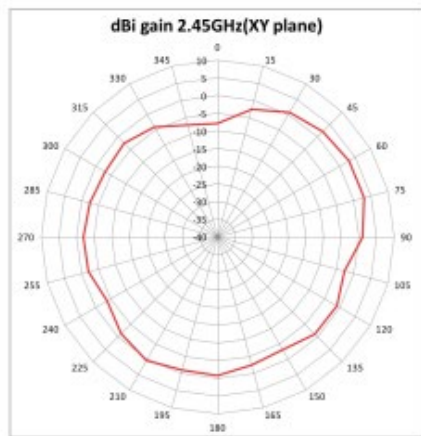

5GHz Antenna

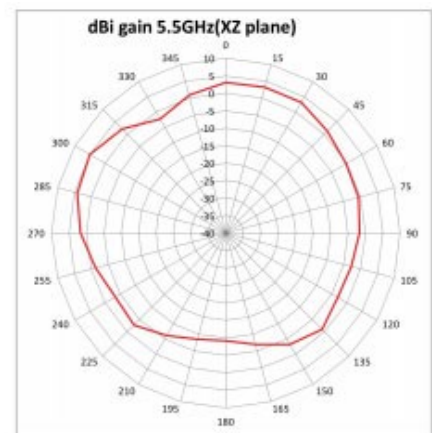
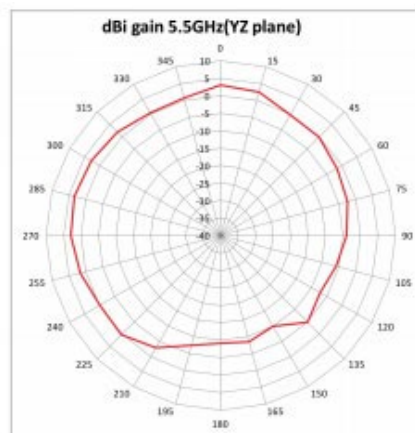
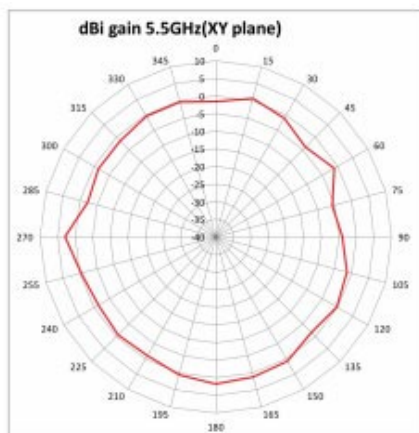

Maximum Transmit Power

For 2.4GHz	
MCS Index	Transmit Power(dBm)
802.11b	
1 Mbps	21
11 Mbps	20
802.11g	
6Mbps	21
54Mbps	18
802.11n HT20	
MCS 0	20
MCS 7	18
802.11n HT40	
MCS 0	20
MCS 7	18

For 5GHz	
MCS Index	Transmit Power(dBm)
802.11a	
6Mbps	21
54Mbps	19
802.11n HT20	
MCS	21
MCS 7	19
802.11n HT40	
MCS 0	20
MCS 7	18
802.11ac VHT80	
MCS 0	20
MCS 7	18
MCS 8	17
MCS 9	16

Country-Wise Max Transmit Powers (dBm)		
Countries	2.4GHz	5Ghz
Australia	20	23
Canada	30	23
India	20	20
Israel	20	20
Japan	20	20
UAE	20	17
USA	20	23

Note:

The actual transmit power will be the lowest of:

- Value specified in the Device Template
- Maximum value allowed in the regulatory domain
- Maximum power supported by the radio

Receive Sensitivity

For 2.4GHz	
MCS Index	Receive Sensitivity (dBm)
802.11g	
6 Mbps	-95
54 Mbps	-77
54Mbps	-72
802.11n HT20	
MCS 0	-94
MCS 7	-74
802.11n HT40	
MCS 0	-92
MCS 7	-71

For 5GHz	
MCS Index	Receive Sensitivity (dBm)
802.11a	
6 Mbps	-93
54 Mbps	-76
802.11n HT20	
MCS 0	-93
MCS 7	-73
802.11n HT40	
MCS 0	89
MCS 7	-71
802.11ac HT20	
MCS 8	-68
802.11ac HT20	
MCS 9	-64
802.11ac HT80	
MCS 9	-61

Access Point Security Modes:

- WPA/WPA2 (802.11i) with TKIP or AES-CCMP encryption and PSK or 802.1x authentication
- Integrated WIPS background wireless scanning and Rogue AP prevention

WIPS Sensor Mode:

- Dedicated dual-band WIPS scanning for complete 24/7 protection from wireless threats

REGULATORY SPECIFICATIONS

RF and Electromagnetic	
Country	Certification
USA	FCC Part 15.247, 15.407
Canada	IC
Europe	CE EN300.328, EN301.893 Countries covered under Europe certification: Austria, Belgium, Cyprus, Denmark, Estonia, Finland, France, Germany, Greece, Hungary, Ireland, Italy, Iceland, Luxembourg, Latvia, Lithuania, Malta, Netherlands, Norway, Poland, Portugal, Spain, Sweden, Slovakia, Slovenia, Switzerland, The Czech Republic, UK.

Safety

Country	Certification
USA	UL 60950
Canada	cUL 60950
European Union (EU)	EN 60950, RoHS

ORDERING INFORMATION
Access Point

Part Number	Description
WGA15723	WatchGuard AP125 and 3-yr Total Wi-Fi Total Wi-Fi includes Wi-Fi Cloud license, Standard Support, WIPS, Engage Captive Portals, Analyze Location Analytics, and Go Mobile Web App
WGA15721	WatchGuard AP125 and 1-yr Total Wi-Fi Total Wi-Fi includes Wi-Fi Cloud license, Standard Support, WIPS, Engage Captive Portals, Analyze Location Analytics, and Go Mobile Web App
WGA15733	WatchGuard AP125 and 3-yr Secure Wi-Fi Secure Wi-Fi includes Wi-Fi Cloud license, Standard Support, and WIPS
WGA15731	WatchGuard AP125 and 1-yr Secure Wi-Fi Secure Wi-Fi includes Wi-Fi Cloud license, Standard Support, and WIPS
WGA15703	WatchGuard AP125 and 3-yr Basic Wi-Fi Basic Wi-Fi includes Fireware Gateway Wireless Controller license and Standard Support
WGA15701	WatchGuard AP125 and 1-yr Basic Wi-Fi Basic Wi-Fi includes Fireware Gateway Wireless Controller license and Standard Support

Power Options

Part Number	Description
WG8599 (US)	WatchGuard 802.3at PoE+ Injector with AC cord (US)
WG8600 (EU)	WatchGuard 802.3at PoE+ Injector with AC cord (EU)
WG8601 (UK)	WatchGuard 802.3at PoE+ Injector with AC cord (UK)
WG8602 (AU)	WatchGuard 802.3at PoE+ Injector with AC cord (AU)
WG8041	Power Supply for WatchGuard AP125

Mounting Options

Part Number	Description
WG8040	Flat Surface Mount Kit Flat surfaces (wall, hard ceiling) mount kit for WatchGuard AP125
WG8026	T-grid Rails (9/16", 15mm) Mount Kit Drop ceiling T-grid rails (9/16", 15mm) mount kit for WatchGuard AP125/AP325/AP420
WG8021	T-grid Rails (interlude and silhouette) Mount Kit Drop ceiling T-grid rails (interlude and silhouette) mount kit for WatchGuard AP125/AP325/AP420
WG8027	T-grid Rails (15/16", 24mm) Mount Kit Drop ceiling T-grid rails (interlude and silhouette) mount kit for WatchGuard AP125/AP325/AP420



WATCHGUARD HAS YOU COVERED, INDOORS AND OUT

No matter what your wireless battleground is – remote offices, guest Wi-Fi, corporate access, public hotspots, outdoor environments – WatchGuard has a range of access points to fit your business needs. WatchGuard’s Wi-Fi packages allow you to quickly and easily find the right set of features your business needs today...and tomorrow.

WatchGuard Wi-Fi Solution	Total Wi-Fi	Secure Wi-Fi	Basic Wi-Fi
Wi-Fi Cloud License	✓	✓	
Wireless Intrusion Prevention System (WIPS) Cloud-managed APs have built-in WIPS to help ensure you have the protection you need from malicious attacks and rogue APs	✓	✓	
GO Mobile Web App Easily set-up your network and configuration from any mobile device	✓	✓	
Customer Engagement Tools Splash pages, social media integration, surveys, coupons, videos, and so much more	✓		
Location-based Analytics Know how and when visitors are using your Wi-Fi, customizable reports and alerts for real-time and historical usage data	✓		
Firebox Gateway Wireless Controller			✓
Standard 24x7 Support Hardware warranty with advance hardware replacement, customer support, and software updates	✓	✓	✓

NO NEED TO RIP AND REPLACE, JUST ADD WIPS

Each WatchGuard access point has the flexibility to operate as both an access point and a dedicated WIPS security sensor. This means that when deployed as dedicated WIPS sensors, the devices work with your existing access points (Cisco, Aruba, Ruckus, Ubiquiti, etc) and add enterprise-grade wireless security protection to your network. In this case, instead of delivering secure Wi-Fi traffic to users, we deliver unprecedented WIPS security protection that is 100% dedicated to scanning the air and protecting your business from wireless threats.

For additional details, talk to your authorized WatchGuard reseller or visit <https://www.watchguard.com/wifi>

About WatchGuard Technologies, Inc.

WatchGuard® Technologies, Inc. is a global leader in network security, secure Wi-Fi, and network intelligence products and services to more than 80,000 customers worldwide. The company’s mission is to make enterprise-grade security accessible to companies of all types and sizes through simplicity, making WatchGuard an ideal solution for distributed enterprises and SMBs. WatchGuard is headquartered in Seattle, Washington, with offices throughout North America, Europe, Asia Pacific, and Latin America. To learn more, visit WatchGuard.com.

